

SDN-C Compact DIN Rail Series

The SDN-C DIN rail power supplies are the next generation of the popular SDN series. These models combine high efficiency and compact size with new visual diagnostic LEDs to offer the most performance available from SolaHD. Essential industrial features such as Sag Immunity, Power Factor Correction, and universal voltage input have been retained in this series. Wide temperature operating range and parallel operation capability make the new SDN-C units suitable to a variety of industrial applications.

Applications

- Industrial Machine Control and Process Control
- Conveying Equipment
- Material Handling
- Vending Machines
- Packaging Equipment and Amusement Park Equipment
- Semiconductor Fabrication Equipment
- DeviceNet™

Features



- Compact packaging to save space on the DIN rail
- Visual diagnostic LEDs for input and output status at a glance
- High MTBF means high reliability and long life
- Higher efficiency saves energy and lowers amount of heat generated in panel
- PowerBoost™ overload capability to start high inrush loads
- Accepts Universal voltage 85-264 Vac, 50/60 Hz input
- Active Power Factor Correction
- Patented DIN rail mounting clip
- User Adjustable output voltage accessible via front face
- Parallel capability standard
- Large, rugged, accessible screw terminals
- Industrial grade design
 - -25°C to 60°C operation without derating
- Fully tested and burned-in at factory
- Highly efficient switching technology
- Five year limited warranty

Certifications and Compliances *

All Models

-  Listed, Ind. Control Equipment, E61379
 - UL 508, CSA C22.2 No. 107.1





-  UL Recognized Component, ITE, E137632
 - UL 60950-1/CSA C22.2 No. 60950-1, 2nd Edition
-  - Low Voltage Directive
 - IEC/EN60950-1, 2nd Edition
- Sag Immunity: SEMI F47
- RoHS Compliant

Models SDN 20-24-100C, SDN 20-24-480CC, SDN 40-24-480C

-  UL Recognized Component, Haz. Loc., E234790
 - ISA 12.12.01, CSA C22.2 No. 213
 - Class I, Division 2, Groups A, B, C, D

Models SDN 5-24-100C, SDN 10-24-100C, SDN 5-24-480C, SDN 10-24-480C

-  UL Recognized Component, Haz. Loc., E234790
 - UL 60079-15/CSA E60079-15
 - Class I, Zone 2, AEx nC IIC, Ex nC IIC
-  ATEX Directive
 - EN60079-0, EN60079-15
 -  II 3 G, Ex nC IIC Gc

Related Products

- SDN-P series
- SDP™ series
- SCP series
- SDU UPS

Accessories

- Chassis Mount Bracket (SDN-PMBRK2)

* Refer to user manual for installation requirements when used in hazardous locations.

The SolaHD Difference

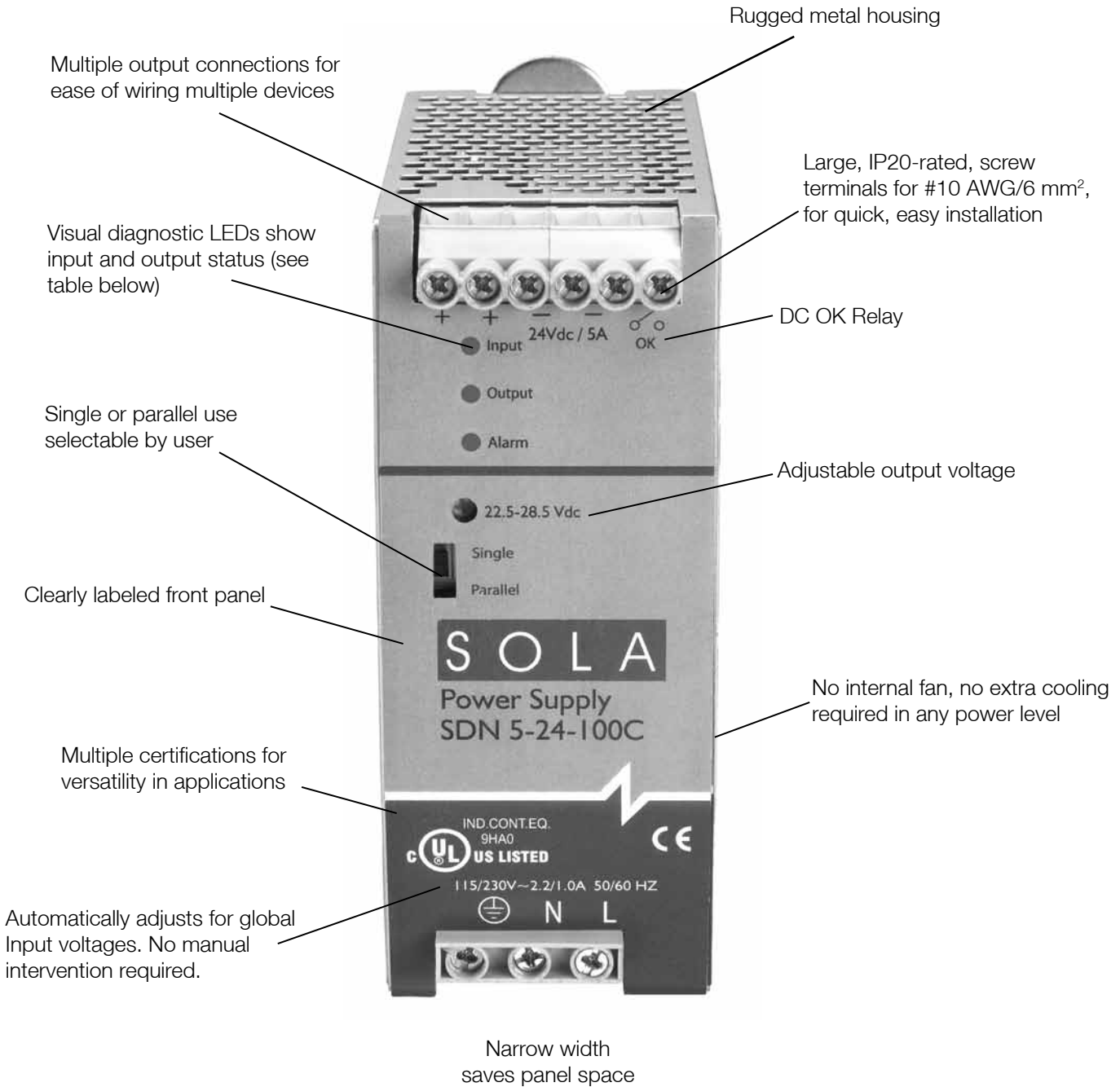

LED Light Status Conditions

	Normal	AC Power Loss	AC Input Low	No DC	High Load	Overload	Hot	Too Hot
Input	Green	-	Yellow	Green	Green	Green	Green	Green
Output	Green	-	Green	-	Yellow	Yellow	Green	-
Alarm	-	-	-	Red	Yellow	Red	Yellow	Yellow

SDN-C Specifications (Single Phase)

Description	Catalog Number		
	SDN 5–24–100C	SDN 10–24–100C	SDN 20–24–100C
Input			
Nominal Voltage	115/230 Vac		
–AC Range	85 - 264 Vac		
–DC Range ¹	90 - 375 Vdc		
–Frequency	43 - 67 Hz		
Nominal Current ²	1.65 - 0.55 A	3.2 - 1.0 A	6 A / 3 A
–Inrush current max.	Typ. < 15 A	Typ.< 30 A	< 40 A
Efficiency (Losses ³)	> 90% typ. (12 W)	> 90% typ. (24 W)	> 92% (38 W)
Power Factor Correction	Active power factor correction to better than 0.92		
Output			
Nominal Voltage	24 V (23.5~28.5 Vdc Adj.)		
–Tolerance	< ±2 % overall (combination Line, load, time and temperature related changes)		
Initial Voltage Setting	24.5 V ± 1%		
–Ripple ⁴	< 50 mVpp		<100 mVpp
PAR	PAR (Periodic and Random Deviation) = 100 mV peak-peak max		
Overvoltage Protection	> 30.5 but < 33 Vdc, auto recovery		
Power Back Immunity	< 35 V		
Nominal Current	5 A (120 W)	10 A (240 W)	20 A (480 W)
–Peak Current ⁵	1.5 x Nominal Current for 2 seconds minimum while holding voltage > 20 Vdc		
–Short Circuit Current	1.5 x Nominal Current at near zero volts at short circuit condition		
–Current Limit	PowerBoost™		
Parallel Operation	Switch selectable single unit or parallel unit operation. Units will not be damaged by parallel operation (regardless of switch position setting).		
Holdup Time	>20 ms (Full load, 100 Vac Input @ T _{amb} =+25°C) to 95% output voltage		
Voltage Fall Time	<150 ms from 95% to 10% rated voltage @ full load (T _{amb} =+25°C)		
Line and Load Regulation	< 0.5%		
General			
EMC: –Emissions	EN61000-6-2:2001, EN61000-6-3:2001, Class B EN55011, EN55022 Radiated and Conducted including Annex. A, EN61000-3-2		
–Immunity	EN61000-6-1:2001, EN61000-6-2:2001, EN61000-4-2 Level 4, EN61000-4-3 Level 3, EN61000-4-6 Level 3, EN61000-4-4 Level 4 input and level 3 output. EN61000-4-5 Isolation class 4, EN61000-4-11, IEC 61000-4-34 voltage dip immunity standard		
Temperature ⁶	Storage: -40°C to + 85°C, Operation -25°C to +60°C full power, with linear derating to half power from 60 to 70°C (Convection cooling, no forced air required). Operation up to 50% load permissible with sideways or front side up mounting orientation.		
MTBF ⁷	> 550,000 hrs		> 450,000 hrs
Warranty	5 Year Limited Warranty		
General Protection/Safety	Protected against continuous short -circuit, continuous overload, continuous open circuit. Protection Class 1 (IEC536), degree of protection IP20 (IEC60529) Safe low voltage: SELV (acc. IEC60950-1)		
Status Indicators	Visual: 3 status LEDs (Input, Output, Alarm) Relay: N.O. contact rated 200ma/50 Vdc		
Installation			
Fusing –Input	Internally fused		
–Output	Outputs are capable of providing high currents for short periods of time for inductive load startup or switching. Fusing may be required for wire/loads if 2x Nominal O/P current rating cannot be tolerated. Continuous current overload allows for reliable fuse tripping.		
Mounting	Simple snap-on to DIN TS35/7.5 or TS35/15 rail system.		
Connections	Input: Screw terminals, connector size range: 16-10 AWG (1.5-6 mm ²) for solid conductors. Output: Two terminals per output, connector size range: 16-10 AWG (1.5-6 mm ²) for solid conductors.		
Case	Fully enclosed metal housing with fine ventilation grid to keep out small parts.		
–Free Space	15 mm in front, 25 ~ 40 mm above and below, 10 mm left and right.		
H x W x D inches (mm)	4.85 x 1.97 x 4.36 (123.0 x 50.0 x 110.0)	4.85 x 2.36 x 4.36 (123.0 x 60.0 x 110.0)	4.85 x 3.42 x 4.98 (123.0 x 87.0 x 127.0)
Weight lbs (kg)	1.1 (0.50)	1.7 (0.80)	2.6 (1.20)

1. Not UL listed for DC input.

2. Input current ratings are conservatively specified with low input, worst case efficiency and power factor.

3. Losses are heat dissipation in watts at full load, nominal input line.

4. Ripple/noise is stated as typical values when measured with a 20 MHz, bandwidth

scope and 50 Ohm resistor.

5. Peak current is calculated at 24 Volt levels.

6. Contact tech support for operation at -25°C.

7. Demonstrated through extended life test.

SDN-C Specifications (Three Phase)

Description	Catalog Number			
	SDN 5-24-480C	SDN 10-24-480C	SDN 20-24-480CC	SDN 40-24-480C
Input				
Nominal Voltage	380 - 480 Vac			
Two - phase input	Yes ¹			
-AC Range ²	320 - 540 Vac			
-DC Range	450 - 760 Vdc	450 - 760 Vdc	450 - 760 Vdc ⁹	N/A
-Frequency	50/60 Hz			
Nominal Current ³	3 x 0.5 or 2 x 0.7 A	3 x 0.8 or 2 x 1.2 A	3 x 0.9 or 2 x 1.3 A	3 x 1.6 A
-Inrush current max.	Typ. <25 A		Negligible	Negligible
Efficiency (Losses ⁴)	> 85% (18 W)	91.2% (23.6 W)	93% (42 W)	94% (78 W)
Power Factor Correction	Power factor correction to meet EN61000-3-2 Class A		Active Power Factor Correction	
Output				
Turn on time	Typ. 1s			
Voltage Rise Time	ca. 5-20 ms		<100 ms full resistive load (T _{amb} = +25°C)	
Power Back Immunity	<35 V			
Overvoltage Protection	>30.5 but <33 Vdc auto recovery			
Nominal Voltage	24 V (24 - 28 Vdc Adjustable)			
Voltage Regulation	< ±2 % overall			
Initial Voltage Setting	24.5 V ± 1%			
-Ripple ⁵	<100 mVpp			
PAR	PAR = 100 mV peak-peak max		PAR = 200 mV peak-peak max	
Nominal Current	5 A (120 W)	10 A (240 W)	20 A (480 W) (constant power, not constant current)	40 A (960 W)
-Peak Current ⁶	6A, 2xNominal Current <2sec	12A, 2xNominal Current <2sec	1.5xNominal Current for 4 sec minimum while holding voltage > 20Vdc	
-Current Limit	PowerBoost™			
Derating	typ. 6 W/°C	typ. 12 W/°C	typ. 24 W/°C	typ. 48 W/°C
Holdup Time	>20 ms		>15 ms	
Voltage Fall Time	<150 ms from 95% to 10% rated voltage @ full load (T _{amb} = +25°C)		<50 ms from 95% to 10% rated voltage @ full load (T _{amb} = +25°C)	
Parallel Operation ⁷	Single or Parallel operation selectable via front switch. For redundant operation, use of external diode module is preferred			SDN 40 uses active paralleling
General				
Case	Fully enclosed metal housing with fine ventilation grid to keep out small parts.			
Min. Required	25mm above and below or 15mm in front	25mm above and below or 10mm in front	70mm above and below or 25mm in front and 25mm left & right	70mm above and below, 15mm in front, 25mm left & right
Free Space				
HxWxD inches (mm)	4.85 x 1.97 x 4.36 (123.0 x 50.0 x 111.0)	4.85 x 2.36 x 4.36 (123.0 x 60.0 x 111.0)	4.85 x 3.35 x 4.68 (123.0 x 85.0 x 119.0)	4.85 x 7.09 x 4.66 (123.0 x 180.0 x 119.0)
Weight lbs (kg)	1.2 (.52)	1.5 (0.70)	2.9 (1.30)	5.3 (2.40)
EMC: -Emissions	EN61000-6-3:2001, Class B EN55011, EN55022 Radiated and Conducted including Annex. A, EN61000-3-2			
-Immunity	EN61000-6-1:2001, EN61000-6-2:2001, EN61000-4-2 Level 4, EN61000-4-3 Level 3, EN61000-4-6 Level 3, EN61000-4-4 Level 4 input and level 3 output. EN61000-4-5 Isolation class 4, EN61000-4-11			
Temperature	Storage : -40 to + 85°C, Operation -25 to +60°C full power, with linear derating to half power from 60 to 70°C (Convection cooling, no forced air required). Operation up to 50% load permissible with sideways or front side up mounting orientation.			
Humidity	< 90% RH, noncondensing; IEC 60068-2-2, 68-2-3			
Altitude	0 to 3000 meters (0 to 10,000 feet)			
Vibration	2.5(g) RMS, 10-2000 Hz (random); three axes for 20 minutes each - IEC 60068-2-6			
Shock	3(g) peak, three axes, 11mseconds for each axis - IEC 60068-2-27			
Warranty	5 Year Limited Warranty			
MTBF	>500,000 hrs MTBF (Nominal voltage, full load, T _{amb} = 25°C)			
General Protection/Safety	Protected against short -circuit, overload, open circuit. Protection class 1 (IEC536), degree of protection IP20 (IEC 529) Safe low voltage: SELV (acc. EN60950)			
Over-temperature protection	LED Alarm, Output shutdown with automatic restart			
Status Indicators	Visual: 3 status LEDs (Input, Output, Alarm) Relay: SSR or dry relay contact, signal active when V _{out} = 18.5 Vdc = +/-5%			
Installation				
Fusing: -Input	Externally fused			
-Output	Not fused. Output is capable of providing high currents (PowerBoost) for motor load startup.			
Mounting	Simple snap-on to DIN TS35/7.5 or TS35/15 rail system. Unit should handle normal shock and vibration of industrial use and transportation without falling off the rail.			
Connections ⁸	Input: screw terminals, Wiring for the connector will be Ground on the left (when looking at the front of the unit), connector size range: 16-10AWG (1.5-6mm ²) for solid conductors. Output: connector size range, wire gauge 6-7 AWG for SDN40; all other models: 16-10AWG (1.5-6mm ²) for solid conductors.			

1. SDN 20 will operate at 75% load; SDN 40 will operate at 50% load under loss of 1 phase; SDN 5 and SDN 10 will operate with single phase input power at 100% of load. Unit will shut down if thermal threshold is exceeded under this condition.

2. Unit passed input voltage overstress test at 600 Vac without failure.

3. Input current ratings are specified with low input, line conditions, worst case efficiency values and power factor spikes. Input current at nominal input settings will typically be half these values.

4. Losses are heat dissipation in watts at full load, nominal line.

5. Ripple/noise is stated as typical values when measured with a 20 MHz, bandwidth scope and 50 Ohm resistor.

6. SDN 20 and 40 unit will go to HICCUP mode. SDN 5 and 10 will maintain min 4 secs to deliver 150% load then drops to almost zero V_{out}. The output voltage will immediately drop to almost zero when load rises above 150%.

7. All models except the 40amp unit are capable of parallel operation by use of a jumper pin, accessible by the end user. 40 amp unit will have active current sharing signal.

8. SDN 40-24-480C only = Output signaling terminal block features (Shut down, Power Good, Current Monitor, Current Balance, signal GND).

9. 70% maximum rated load.

SDN-C Series Dimensions

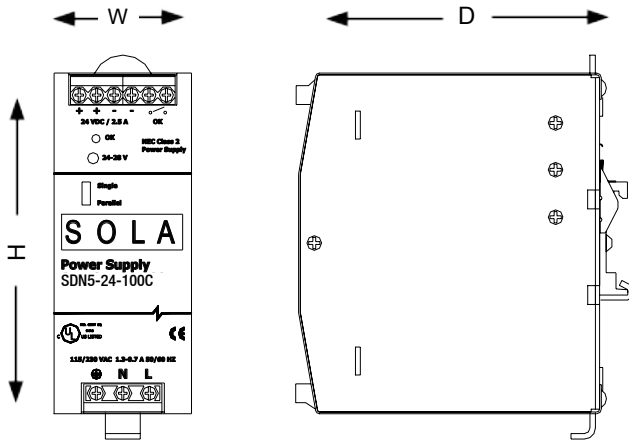

Catalog Number	Dimensions – inches (mm)		
	H	W	D
SDN 5–24–100C	4.85 (123.0)	1.97 (50.0)	4.36 (111.0)
SDN 10–24–100C	4.85 (123.0)	2.36 (60.0)	4.36 (111.0)
SDN 20–24–100C	4.85 (123.0)	3.42 (87.0)	4.98 (127.0)
SDN 5–24–480C	4.85 (123.0)	1.97 (50.0)	4.36 (111.0)
SDN 10–24–480C	4.85 (123.0)	2.36 (60.0)	4.36 (111.0)
SDN 20–24–480CC	4.85 (123.0)	3.35 (85.0)	4.68 (119.0)

SDN 40-24-480C Dimensions

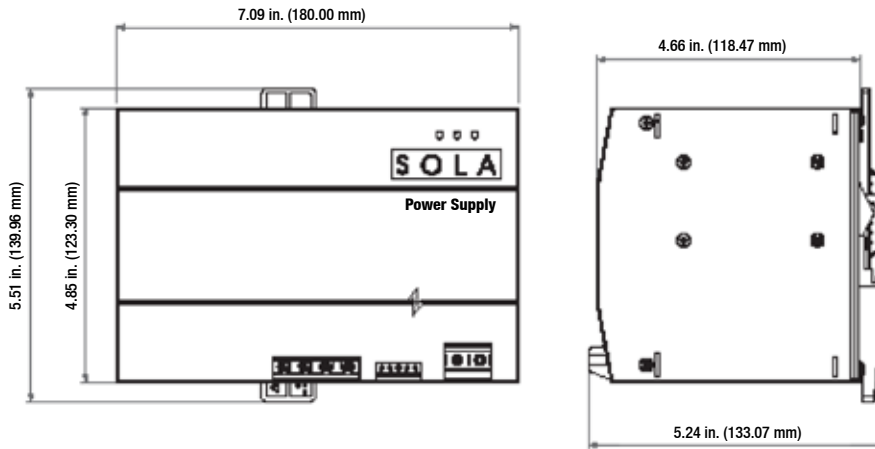

SDN-C Series Mounting (cont.)

Chassis Mounting

Instead of snapping a SolaHD SDN™ unit on the DIN Rail, you can also attach it using the screw mounting set SDN-PMBRK2.

This set consists of two metal brackets, which replace the existing two aluminum profiles.

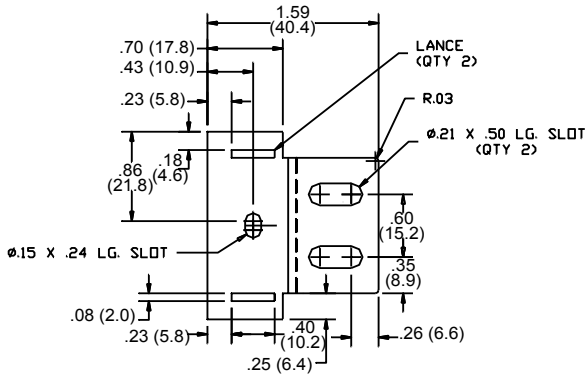

Dimensional Diagram - in (mm)

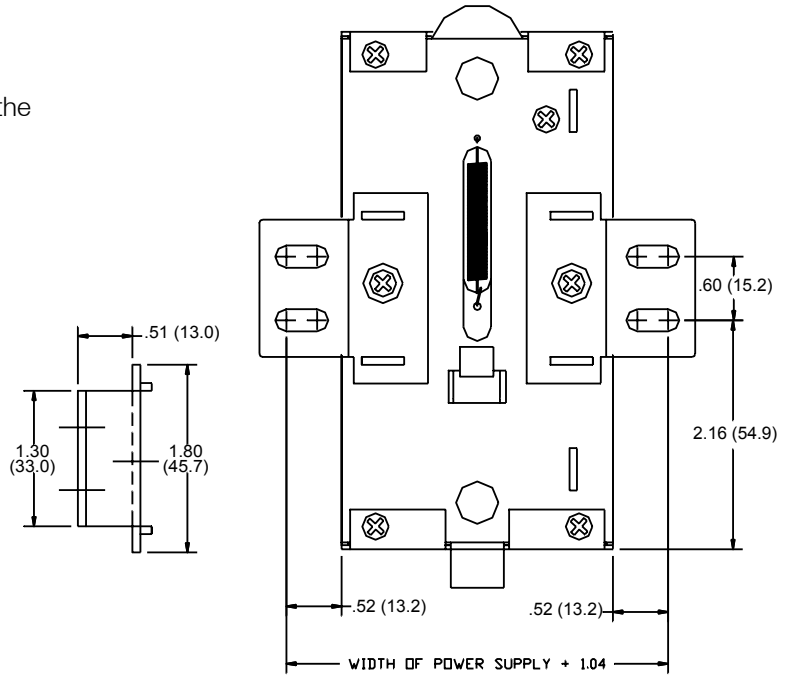

SDN-C Series Mounting

DIN Rail Mounting

Snap on the DIN Rail:

1. Tilt unit slightly backwards
2. Put it onto the DIN Rail
3. Push downwards until stopped
4. Push at the lower front edge to lock
5. Shake the unit slightly to ensure that the retainer has locked

Alternative Panel Mount: Using the optional SDN-PMBRK2 accessory, the unit can be screw mounted to a panel.

Detachment from DIN Rail:

